

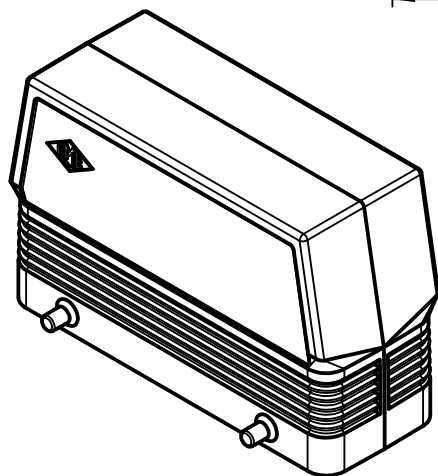
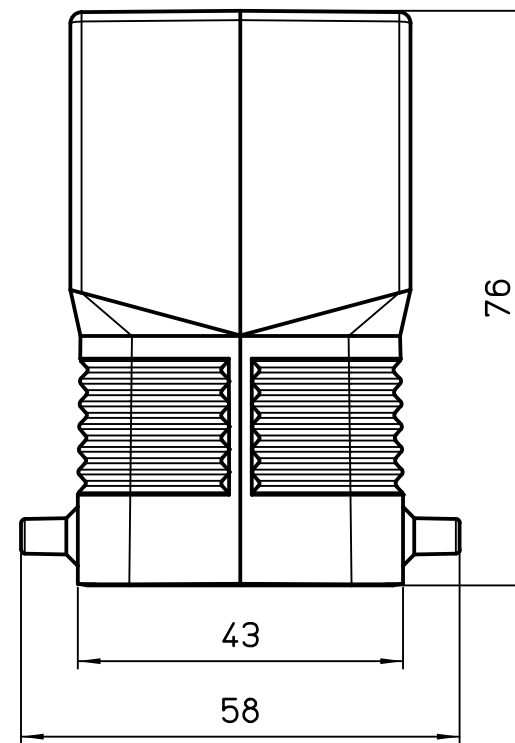
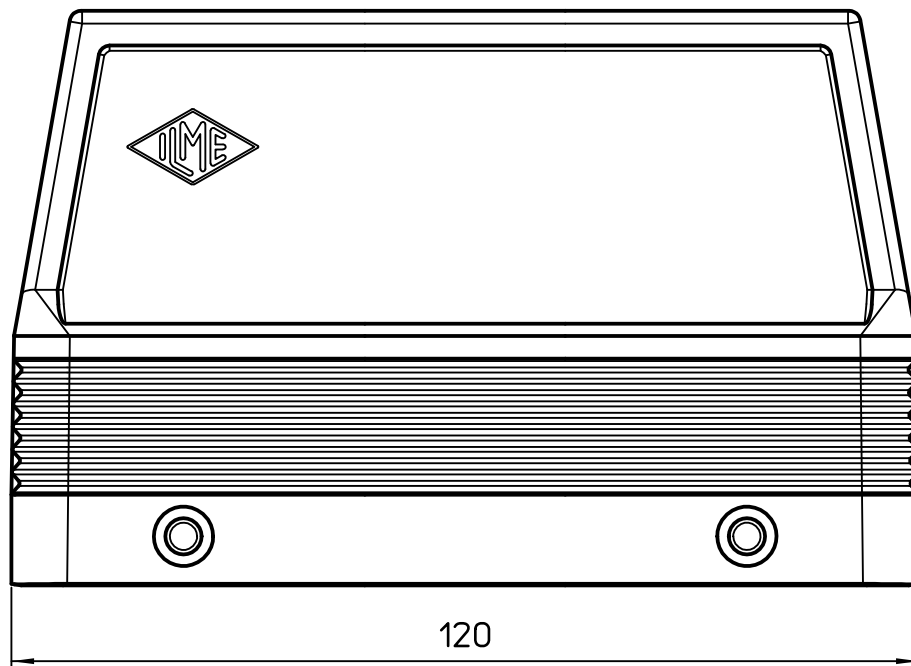

Diritti riservati All rights reserved

1

2

3



REV.	DATE	SIGNATURE		
Dimensions in mm		Simplified representation with dimensions without tolerance		
Original Size A4		CACR 24		Scale 1:1 
Date 19/09/22		Hood with pegs, size "104.27", high construction, without entry, to be drilled, 180 °C		
Sign. S.Diasparra				

1

2

3